

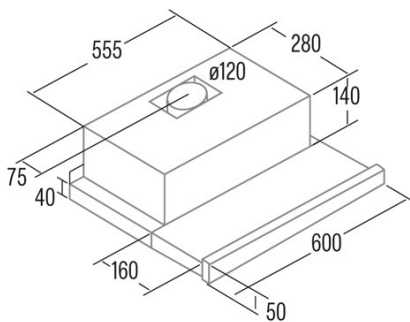

# TF-2003 600 GBK

Cod. 02017203

EAN 8422248062015



## INFORMACIÓN GENERAL

EAN/UPC	8422248062015
Subfamily	Telescopic

### Product fiche according to directives EU65/2014 - EN61591, EN60704-2-13, EN50564

AEC (Energy consumption per year) (kWh/año)	44,5
EEl class (Energy efficiency class)	C
FDE (Fluid dynamic efficiency)	11,9
FDE class (Fluid dynamic efficiency class)	E
LE (Light efficiency) (lux/W)	36
LE class (Light efficiency class)	A
GFE (Grease filtering efficiency)	68
GFE Class (Grease filtering efficiency class)	D
Normal mode airflow MIN (m3/h)	150
Normal mode airflow MAX (m3/h)	390
Normal mode acustic power MIN (dB)	45
Normal mode acustic power MAX (dB)	57
Po (Off-mode power consumption) (W)	0
Ps (Stand-by power consumption) (W)	0

### Integration directive EU 66/2014

f (Factor Increase in the time)	1,6
EEl (Energy efficiency Index)	78,2
QBEP (Maximum airflow point efficiency) (m3/h)	198,2
PBEP (Maximum pressure point efficiency) (Pa)	148
WBEP (Electrical power consumption at maximum efficiency) (W)	68,6
WL (Rated power lighting system) (W)	7
EMIDDLE (Average illuminance on the cooking surface) (lux)	252

### External Dimensions

Width (mm)	600
Depth (mm)	280
Maximum Total Height (mm)	180
Minimum Total Height (mm)	140
Outlet Diameter (mm)	120

### Characteristics

Motor Quantity	1
Motor Model	TF2003
Maximum Pressure (Pa)	194
Filter Technology	Aluminium mesh
Control Tecnology	Mechanical push button
Booster	-
Power levels	2
Timer	-
Filter Saturation Indicator	-
Charcoal Filter Change Indicator	-
Dimmer Function	-
Connectivity	-
Remote control	-
Display	-

### Lighting

Light Model	EcoLed
Lightning Technology	LED

### Installation

Minimum distance to an electric cooktop (mm)	550
Minimum distance to a gas cooktop (mm)	650
Recirculation Option	√

Charcoal Filter	-
Back Draught Shutter	-
Inner shield	√

---

#### Electric Connection

Rated voltage (V)	220-240
Rated frequency (Hz)	50
Rated power input (W)	107
Protection against electric shock	Class I
Power cord length (m)	1,5
Plug type	No plug

---

#### Accessories

Upper Decorative Duct Extension	No
White Decorative Duct	No
Black Decorative Duct	No
Island Tube Enhancer	No
Back Draught Shutter	2849003
MAX PRO Metal Filter	No
Active Charcoal Filter	2825263
Noiseless Flexible Duct	No
Recirculating kit	No

---