

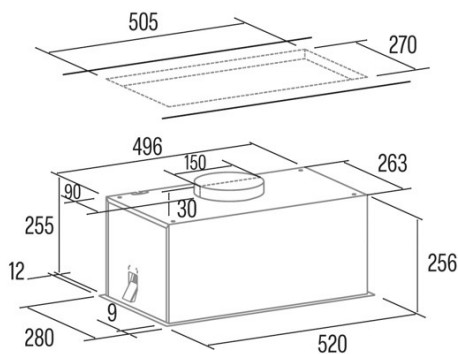

GPL 52 X

Cod. 02030304

EAN 8422248198479

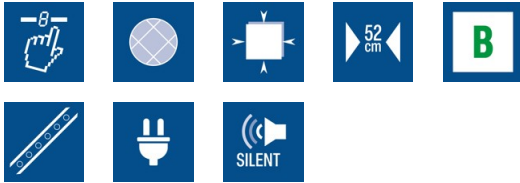

INFORMACIÓN GENERAL

EAN/UPC	8422248198479
Subfamily	Insert

Product fiche according to directives EU65/2014 - EN61591, EN60704-2-13, EN50564

AEC (Energy consumption per year) (kWh/año)	62,2
EEl class (Energy efficiency class)	B
FDE (Fluid dynamic efficiency)	22,2
FDE class (Fluid dynamic efficiency class)	C
LE (Light efficiency) (lux/W)	30,2
LE class (Light efficiency class)	A
GFE (Grease filtering efficiency)	66,3
GFE Class (Grease filtering efficiency class)	D
Normal mode airflow MIN (m3/h)	235
Normal mode airflow MAX (m3/h)	529
Normal mode acustic power MIN (dB)	48
Normal mode acustic power MAX (dB)	68
Po (Off-mode power consumption) (W)	0
Ps (Stand-by power consumption) (W)	0

Integration directive EU 66/2014

f (Factor Increase in the time)	1,2
EEl (Energy efficiency Index)	68,7
QBEP (Maximum airflow point efficiency) (m3/h)	295,5
PBEP (Maximum pressure point efficiency) (Pa)	360
WBEP (Electrical power consumption at maximum efficiency) (W)	132,9
WL (Rated power lighting system) (W)	121
EMIDDLE (Average illuminance on the cooking surface) (lux)	4

Characteristics

Motor Quantity	1
Maximum Pressure (Pa)	482
Filter Technology	Aluminium mesh
Control Tecnology	Electronic Soft Touch
Power levels	3

Lighting

Light Model	ECOLED STRIP
Lightning Technology	LED

Electric Connection

Rated voltage (V)	220-240
Rated frequency (Hz)	50
Rated power input (W)	192
Protection against electric shock	Class I
Power cord length (m)	1,2
Plug type	No plug