

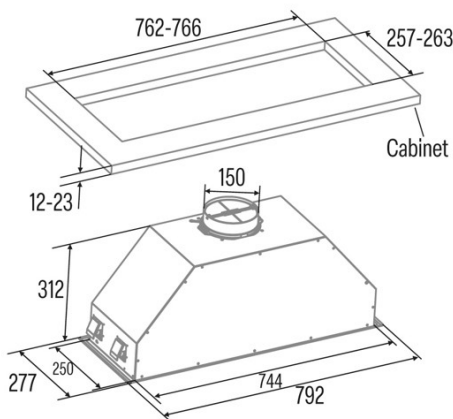

GT-PLUS 75 X

Cod. 02031301

EAN 8422248190381



INFORMACIÓN GENERAL

EAN/UPC	8422248190381
Subfamily	Insert

Product fiche according to directives EU65/2014 - EN61591, EN60704-2-13, EN50564

AEC (Energy consumption per year) (kWh/año)	886
EEl class (Energy efficiency class)	C
FDE (Fluid dynamic efficiency)	163
FDE class (Fluid dynamic efficiency class)	D
LE (Light efficiency) (lux/W)	283
LE class (Light efficiency class)	A
GFE (Grease filtering efficiency)	912
GFE Class (Grease filtering efficiency class)	B
Normal mode airflow MIN (m3/h)	300
Normal mode airflow MAX (m3/h)	645
Normal mode acustic power MIN (dB)	50
Normal mode acustic power MAX (dB)	65
Po (Off-mode power consumption) (W)	0
Ps (Stand-by power consumption) (W)	0

Integration directive EU 66/2014

f (Factor Increase in the time)	1,4
EEl (Energy efficiency Index)	811
QBEP (Maximum airflow point efficiency) (m3/h)	358,1
PBEP (Maximum pressure point efficiency) (Pa)	270
WBEP (Electrical power consumption at maximum efficiency) (W)	164,9
WL (Rated power lighting system) (W)	6
EMIDDLE (Average illuminance on the cooking surface) (lux)	170

External Dimensions

Width (mm)	792
Depth (mm)	277
Maximum Total Height (mm)	312
Minimum Total Height (mm)	312
Outlet Diameter (mm)	150, 125

Characteristics

Motor Quantity	1
Motor Model	BT2
Maximum Pressure (Pa)	400
Filter Technology	Aluminium mesh
Control Tecnology	Mechanical push button
Booster	-
Power levels	3
Timer	-
Filter Saturation Indicator	-
Charcoal Filter Change Indicator	-
Dimmer Function	-
Connectivity	No
Remote control	-
Display	-

Lighting

Light Model	CSLED
Lightning Technology	LED

Installation

Minimum distance to an electric cooktop (mm)	550
Minimum distance to a gas cooktop (mm)	650
Recirculation Option	√

Charcoal Filter	-
Back Draught Shutter	-
Inner shield	-

Electric Connection

Rated voltage (V)	220-240
Rated frequency (Hz)	50
Rated power input (W)	206
Protection against electric shock	Class II
Power cord length (m)	15
Plug type	Type C

Accessories

Active Charcoal Filter	02859398
------------------------	----------
