

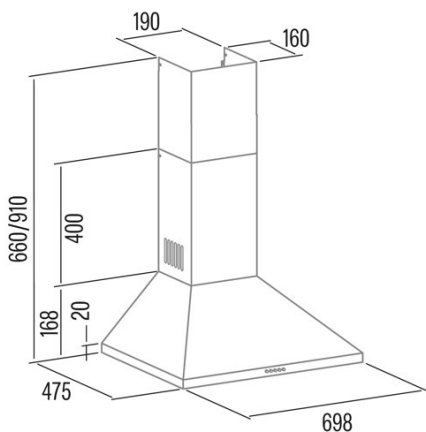

# V-700 X

Cod. **02085600**

EAN **8422248087285**



## INFORMACIÓN GENERAL

EAN/UPC	8422248087285
Subfamily	Chimney

### Product fiche according to directives EU65/2014 - EN61591, EN60704-2-13, EN50564

AEC (Energy consumption per year) (kWh/año)	53,7
EEl class (Energy efficiency class)	C
FDE (Fluid dynamic efficiency)	10,3
FDE class (Fluid dynamic efficiency class)	E
LE (Light efficiency) (lux/W)	8,4
LE class (Light efficiency class)	E
GFE (Grease filtering efficiency)	71,4
GFE Class (Grease filtering efficiency class)	D
Normal mode airflow MIN (m3/h)	210
Normal mode airflow MAX (m3/h)	420
Normal mode acustic power MIN (dB)	53
Normal mode acustic power MAX (dB)	65
Po (Off-mode power consumption) (W)	0
Ps (Stand-by power consumption) (W)	0

### Integration directive EU 66/2014

f (Factor Increase in the time)	1,6
EEl (Energy efficiency Index)	84,4
QBEP (Maximum airflow point efficiency) (m3/h)	220
PBEP (Maximum pressure point efficiency) (Pa)	130
WBEP (Electrical power consumption at maximum efficiency) (W)	76,9
WL (Rated power lighting system) (W)	11
EMIDDLE (Average illuminance on the cooking surface) (lux)	208,8

### External Dimensions

Width (mm)	700
Depth (mm)	475
Maximum Total Height (mm)	910
Minimum Total Height (mm)	610
Outlet Diameter (mm)	150, 125

### Characteristics

Motor Quantity	1
Motor Model	K7PLUS
Maximum Pressure (Pa)	200
Filter Technology	Aluminium mesh
Control Tecnology	Mechanical push button
Booster	-
Power levels	3
Timer	-
Filter Saturation Indicator	-
Charcoal Filter Change Indicator	-
Dimmer Function	-
Connectivity	-
Remote control	-
Display	-

### Lighting

Light Model	LED E-14
Lightning Technology	LED

### Installation

Minimum distance to an electric cooktop (mm)	650
Minimum distance to a gas cooktop (mm)	650
Recirculation Option	√

Charcoal Filter	-
Back Draught Shutter	-
Inner shield	-

---

### Electric Connection

Rated voltage (V)	220-240
Rated frequency (Hz)	50
Rated power input (W)	106
Protection against electric shock	Class II
Power cord length (m)	1,5
Plug type	Type C

---

### Accessories

Upper Decorative Duct Extension	2862302
White Decorative Duct	No
Black Decorative Duct	No
Island Tube Enhancer	No
Back Draught Shutter	2832004
MAX PRO Metal Filter	2800917
Active Charcoal Filter	2859394
Noiseless Flexible Duct	2893002
Recirculating kit	No

---