

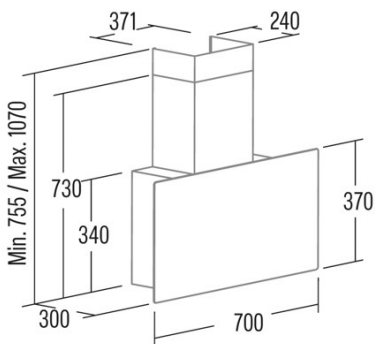

# GRECO 70 WH CATA&ROCA

Cod. 02133007

EAN 8422248084123



## INFORMACIÓN GENERAL

EAN/UPC	8422248084123
Subfamily	Angle Glass

### Product fiche according to directives EU65/2014 - EN61591, EN60704-2-13, EN50564

AEC (Energy consumption per year) (kWh/año)	56,3
EEl class (Energy efficiency class)	A
FDE (Fluid dynamic efficiency)	30,6
FDE class (Fluid dynamic efficiency class)	A
LE (Light efficiency) (lux/W)	28,7
LE class (Light efficiency class)	A
GFE (Grease filtering efficiency)	91,2
GFE Class (Grease filtering efficiency class)	B
Normal mode airflow MIN (m3/h)	340
Normal mode airflow MAX (m3/h)	600
Boost mode airflow (m3/h)	850
Normal mode acoustic power MIN (dB)	50
Normal mode acoustic power MAX (dB)	65
Boost mode acoustic power (dB)	67
Po (Off-mode power consumption) (W)	0,43
Ps (Stand-by power consumption) (W)	0

### Integration directive EU 66/2014

f (Factor Increase in the time)	0,9
EEl (Energy efficiency Index)	53,7
QBEP (Maximum airflow point efficiency) (m3/h)	416,9
PBEP (Maximum pressure point efficiency) (Pa)	411
WBEP (Electrical power consumption at maximum efficiency) (W)	155,7
WL (Rated power lighting system) (W)	7
EMIDDLE (Average illuminance on the cooking surface) (lux)	201

### External Dimensions

Width (mm)	700
Depth (mm)	290
Maximum Total Height (mm)	1160
Minimum Total Height (mm)	845
Outlet Diameter (mm)	150, 125

### Characteristics

Motor Quantity	1
Motor Model	BT3
Maximum Pressure (Pa)	450
Filter Technology	Aluminium mesh
Control Technology	Electronic Touch Control
Booster	√
Power levels	4
Timer	√
Filter Saturation Indicator	√
Charcoal Filter Change Indicator	-
Dimmer Function	√
Connectivity	-
Remote control	-
Display	Display_grafico

### Lighting

Light Model	ECOLED 2
Lightning Technology	LED

### Installation

Minimum distance to an electric cooktop (mm)	530
--	-----

Minimum distance to a gas cooktop (mm)	650
Recirculation Option	√
Charcoal Filter	-
Back Draught Shutter	-
Inner shield	-

---

### Electric Connection

Rated voltage (V)	220-240
Rated frequency (Hz)	50
Rated power input (W)	287
Protection against electric shock	Class II
Plug type	Type C

---

### Accessories

Upper Decorative Duct Extension	2861303
White Decorative Duct	2861003
Black Decorative Duct	No
Island Tube Enhancer	No
Back Draught Shutter	2832004
MAX PRO Metal Filter	No
Active Charcoal Filter	2859398
Noiseless Flexible Duct	2893002
Recirculating kit	No

---