

ARMONIA 90 X

Cod. **02189309**

EAN **8422248110587**

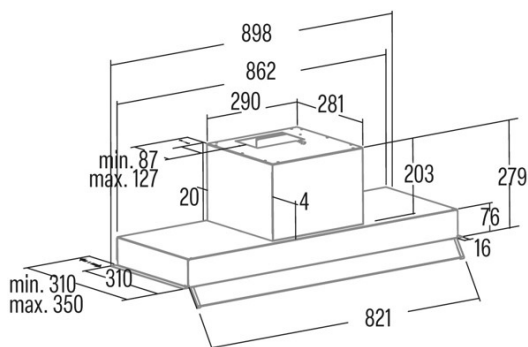

GENERAL INFORMATION

EAN/UPC	8422248110587
Subfamily	Integrated

Product sheet according to directives EU65/2014 - EN61591, EN60704-2-13, EN50564

AEC (Annual energy consumption) (kWh/year)	100,9
EEL class (energy efficiency class)	C
FDE (fluid dynamic efficiency)	16,3
FDE class (fluid dynamic efficiency class)	D
LE (light efficiency) (Lux/W)	21,4
LE class (light efficiency class)	B
GFE (grease filtering efficiency)	88,5
GFE class (grease filtering efficiency class)	B
Airflow in normal mode MIN (m3/h)	385
Airflow in normal mode MAX (m3/h)	645
Acoustic power in normal mode MIN (dB)	56
Acoustic power in normal mode MAX (dB)	70
Po (energy consumption in off mode) (W)	0
Ps (energy consumption in standby mode) (W)	0

Integration directive EU 66/2014

f (time increase factor)	1,4
EEL (Energy Efficiency Index)	82,4
QBEP (maximum efficiency at air flow point) (m3/h)	375,3
PBEP (maximum efficiency at pressure point) (Pa)	295
WBEP (power consumption at maximum efficiency) (W)	188,8
WL (nominal power lighting system) (W)	6
EMIDDLE (Average illuminance on the cooking surface) (lux)	269

External Dimensions

Width (mm)	898
Depth (mm)	310
Maximum total height (mm)	280
Minimum total height (mm)	280
Diamètre de sortie (mm)	150, 125

Characteristics

Motor quantity	1
Motor model	TA
Maximum pressure (Pa)	430
Filter technology	Aluminium mesh
Control technology	Mechanical push button
Booster	-
Power levels	3
Timer	-
Filter saturation indicator	-
Charcoal filter replacement indicator	-
Dimmer function	-
Connectivity	No
Remote control	-
Display	-

Lighting

Light model	CSLED
Ray technology	LED

Installation

Minimum distance to electric plate (mm)	550
Minimum distance to gas plate (mm)	650
Recirculation option	-
Charcoal filter	√

Back draught shutter	No
Inner shield	-

Electric connection

Nominal voltage (V)	220-240
Nominal frequency (Hz)	50
Nominal input power (W)	276
Electric shock protection	Class II
Plug type	No plug

Accessories

Upper decorative duct extension	02861306
Activated charcoal filter	02859391
Noiseless flexible duct	02893002
