

WANDA 700 XGWH

Cod. **02078006**

EAN **8422248102346**

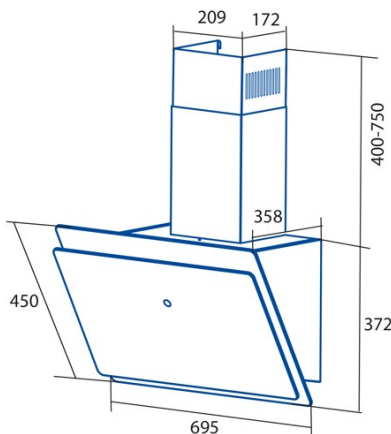

GENERAL INFORMATION

EAN/UPC	8422248102346
Subfamily	Angle Glass

Product sheet according to directives EU65/2014 - EN61591, EN60704-2-13, EN50564

AEC (Annual energy consumption) (kWh/year)	14,94
EEl class (energy efficiency class)	AP
FDE (fluid dynamic efficiency)	31,01
FDE class (fluid dynamic efficiency class)	A
LE (light efficiency) (Lux/W)	54,6
LE class (light efficiency class)	A
GFE (grease filtering efficiency)	78
GFE class (grease filtering efficiency class)	C
Airflow in normal mode MIN (m3/h)	234,1
Airflow in normal mode MAX (m3/h)	522,81
Acoustic power in normal mode MIN (dB)	35
Acoustic power in normal mode MAX (dB)	61,8
Po (energy consumption in off mode) (W)	0,45

Integration directive EU 66/2014

f (time increase factor)	0,883
EEl (Energy Efficiency Index)	38,6
QBEP (maximum efficiency at air flow point) (m3/h)	248,01
PBEP (maximum efficiency at pressure point) (Pa)	178,05
WBEP (power consumption at maximum efficiency) (W)	39,55
WL (nominal power lighting system) (W)	3
EMIDDLE (Average illuminance on the cooking surface) (lux)	163,8

External Dimensions

Width (mm)	695
Depth (mm)	358
Maximum total height (mm)	1122
Minimum total height (mm)	772
Diamètre de sortie (mm)	150

Characteristics

Motor quantity	1
Motor model	BLDC
Maximum pressure (Pa)	430
Free out airflow (m3/h)	1000
Filter technology	Aluminium mesh
Control technology	Electronic Touch Control
Booster	-
Power levels	9
Timer	√
Filter saturation indicator	-
Charcoal filter replacement indicator	-
Dimmer function	-
Connectivity	-
Remote control	-
Display	Display

Lighting

Ray technology	LED
----------------	-----

Installation

Minimum distance to electric plate (mm)	650
Minimum distance to gas plate (mm)	650
Recirculation option	√
Charcoal filter	-
Back draught shutter	Included

Inner shield -

Electric connection

Nominal voltage (V)	220-240
Nominal frequency (Hz)	50/60
Nominal input power (W)	73
Electric shock protection	Class I
Plug type	Type F

Accessories

Upper decorative duct extension	No
White decorative duct	No
Black decorative duct	No
Island tube booster	No
Back draught shutter	Included
MAX PRO Metal filter	No
Activated charcoal filter	2859492
Noiseless flexible duct	2893002
Recirculation kit	2894400
