

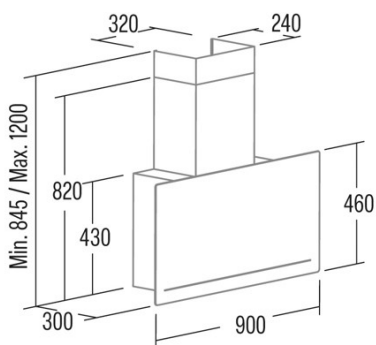

GOYA 90 BK CATA&ROCA

Cod. 02129404

EAN 8422248106108



GENERAL INFORMATION

EAN/UPC	8422248106108
Subfamily	Angle Glass

Product sheet according to directives EU65/2014 - EN61591, EN60704-2-13, EN50564

AEC (Annual energy consumption) (kWh/year)	14,5
EEl class (energy efficiency class)	A+++
FDE (fluid dynamic efficiency)	39,7
FDE class (fluid dynamic efficiency class)	A
LE (light efficiency) (Lux/W)	26,3
LE class (light efficiency class)	B
GFE (grease filtering efficiency)	75,5
GFE class (grease filtering efficiency class)	C
Airflow in normal mode MIN (m3/h)	200
Airflow in normal mode MAX (m3/h)	605
Airflow in boost mode MIN (m3/h)	825
Acoustic power in normal mode MIN (dB)	40
Acoustic power in normal mode MAX (dB)	64
Acoustic power boost mode (dB)	67
Po (energy consumption in off mode) (W)	0,4
Ps (energy consumption in standby mode) (W)	0

Integration directive EU 66/2014

f (time increase factor)	0,6
EEl (Energy Efficiency Index)	29,3
QBEP (maximum efficiency at air flow point) (m3/h)	259,7
PBEP (maximum efficiency at pressure point) (Pa)	326,2
WBEP (power consumption at maximum efficiency) (W)	59,2
WL (nominal power lighting system) (W)	3
EMIDDLE (Average illuminance on the cooking surface) (lux)	79

External Dimensions

Width (mm)	900
Depth (mm)	300
Maximum total height (mm)	1160
Minimum total height (mm)	845
Diamètre de sortie (mm)	150, 125

Characteristics

Motor quantity	1
Motor model	BT4DC
Maximum pressure (Pa)	357
Filter technology	Aluminium mesh
Control technology	Electronic Touch Control
Booster	√
Power levels	5
Timer	√
Filter saturation indicator	√
Charcoal filter replacement indicator	-
Dimmer function	√
Connectivity	-
Remote control	-
Display	Display_grafico

Lighting

Light model	SSLED
Ray technology	LED

Installation

Minimum distance to electric plate (mm)	530
Minimum distance to gas plate (mm)	650

Recirculation option	√
Charcoal filter	-
Back draught shutter	-
Inner shield	-

Electric connection

Nominal voltage (V)	220-240
Nominal frequency (Hz)	50
Nominal input power (W)	135
Electric shock protection	Class II
Plug type	Type C

Accessories

Upper decorative duct extension	02861303
White decorative duct	No
Black decorative duct	02861405
Island tube booster	No
Back draught shutter	02832004
MAX PRO Metal filter	No
Activated charcoal filter	02859398
Noiseless flexible duct	02893002
Recirculation kit	02894001
