

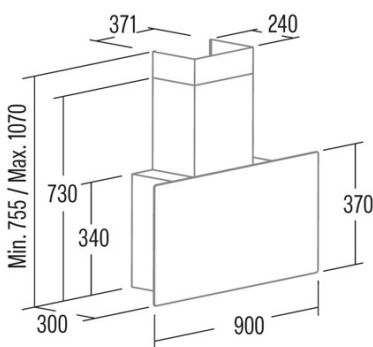

GRECO 90 BK CATA&ROCA

Cod. 02184407

EAN 8422248084093

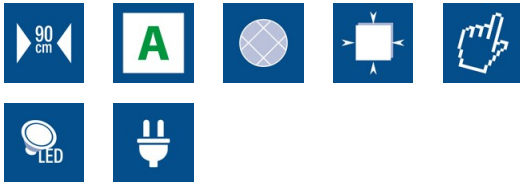

GENERAL INFORMATION

EAN/UPC	8422248084093
Subfamily	Angle Glass

Product sheet according to directives EU65/2014 - EN61591, EN60704-2-13, EN50564

AEC (Annual energy consumption) (kWh/year)	56,3
EEl class (energy efficiency class)	A
FDE (fluid dynamic efficiency)	30,6
FDE class (fluid dynamic efficiency class)	A
LE (light efficiency) (Lux/W)	28,7
LE class (light efficiency class)	A
GFE (grease filtering efficiency)	91,2
GFE class (grease filtering efficiency class)	B
Airflow in normal mode MIN (m3/h)	340
Airflow in normal mode MAX (m3/h)	600
Airflow in boost mode MIN (m3/h)	850
Acoustic power in normal mode MIN (dB)	50
Acoustic power in normal mode MAX (dB)	65
Acoustic power boost mode (dB)	67
Po (energy consumption in off mode) (W)	0,43
Ps (energy consumption in standby mode) (W)	0

Integration directive EU 66/2014

<i>f</i> (time increase factor)	0,9
EEl (Energy Efficiency Index)	53,7
QBEP (maximum efficiency at air flow point) (m3/h)	416,9
PBEP (maximum efficiency at pressure point) (Pa)	411
WBEP (power consumption at maximum efficiency) (W)	155,7
WL (nominal power lighting system) (W)	7
EMIDDLE (Average illuminance on the cooking surface) (lux)	201

External Dimensions

Width (mm)	900
Depth (mm)	290
Maximum total height (mm)	1160
Minimum total height (mm)	845
Diamètre de sortie (mm)	150, 125

Characteristics

Motor quantity	1
Motor model	BT3
Maximum pressure (Pa)	450
Filter technology	Aluminium mesh
Control technology	Electronic Touch Control
Booster	√
Power levels	4
Timer	√
Filter saturation indicator	√
Charcoal filter replacement indicator	-
Dimmer function	√
Connectivity	-
Remote control	-
Display	Display_grafico

Lighting

Light model	ECOLED 2
Ray technology	LED

Installation

Minimum distance to electric plate (mm)	530
Minimum distance to gas plate (mm)	650

Recirculation option	√
Charcoal filter	-
Back draught shutter	-
Inner shield	-

Electric connection

Nominal voltage (V)	220-240
Nominal frequency (Hz)	50
Nominal input power (W)	287
Electric shock protection	Class II
Plug type	Type C

Accessories

Upper decorative duct extension	2861303
White decorative duct	No
Black decorative duct	2861403
Island tube booster	No
Back draught shutter	2832004
MAX PRO Metal filter	No
Activated charcoal filter	2859398
Noiseless flexible duct	2893002
Recirculation kit	No
