

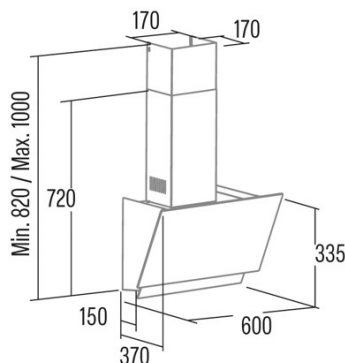

# JUNO 6000 GBK 220-240V 50/60Hz

Cod. 02027700

EAN 8422248355599



## GENERAL INFORMATION

EAN/UPC	8422248355599
Subfamily	Angle Glass

## Product sheet according to directives EU65/2014 - EN61591, EN60704-2-13, EN50564

AEC (Annual energy consumption) (kWh/year)	459
EEl class (energy efficiency class)	A+
FDE (fluid dynamic efficiency)	27,6
FDE class (fluid dynamic efficiency class)	A
LE (light efficiency) (Lux/W)	32
LE class (light efficiency class)	A
GFE (grease filtering efficiency)	67,9
GFE class (grease filtering efficiency class)	D
Airflow in normal mode MIN (m3/h)	170
Airflow in normal mode MAX (m3/h)	387,5
Airflow in boost mode MIN (m3/h)	428
Acoustic power in normal mode MIN (dB)	80
Acoustic power in normal mode MAX (dB)	64
Acoustic power boost mode (dB)	70
Po (energy consumption in off mode) (W)	0,46
Ps (energy consumption in standby mode) (W)	0

## Integration directive EU 66/2014

f (time increase factor)	0,9
EEl (Energy Efficiency Index)	402
QBEP (maximum efficiency at air flow point) (m3/h)	213
PBEP (maximum efficiency at pressure point) (Pa)	261
WBEP (power consumption at maximum efficiency) (W)	60,3
WL (nominal power lighting system) (W)	3
EMIDDLE (Average illuminance on the cooking surface) (lux)	161

## External Dimensions

Width (mm)	600
Depth (mm)	370
Maximum total height (mm)	1000
Minimum total height (mm)	820
Diamètre de sortie (mm)	150

## Characteristics

Motor quantity	1
Motor model	EY450 400 A
Maximum pressure (Pa)	230
Filter technology	Aluminium mesh
Control technology	Electronic Touch Control
Booster	√
Power levels	6
Timer	√
Filter saturation indicator	√
Charcoal filter replacement indicator	√
Dimmer function	√
Connectivity	√
Remote control	-
Display	Display_grafico

## Lighting

Light model	CSLED
Ray technology	LED

## Installation

Minimum distance to electric plate (mm)	400
Minimum distance to gas plate (mm)	650

Recirculation option	√
Charcoal filter	-
Back draught shutter	No
Inner shield	-

---

**Electric connection**

Nominal voltage (V)	220-240
Nominal frequency (Hz)	50/60
Nominal input power (W)	73
Electric shock protection	Class I
Plug type	No plug

---

**Accessories**

Activated charcoal filter	'02859488
Noiseless flexible duct	'02893002

---