

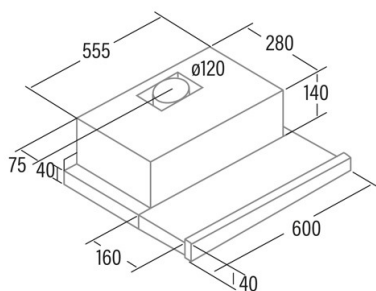

EXTENDER 600

Cod. 02017606

EAN 8422248110334



GENERAL INFORMATION

EAN/UPC	8422248110334
Subfamily	Telescopic

Product sheet according to directives EU65/2014 - EN61591, EN60704-2-13, EN50564

AEC (Annual energy consumption) (kWh/year)	Detail
EEl class (energy efficiency class)	C
FDE class (fluid dynamic efficiency class)	E
LE (light efficiency) (lux/W)	40
LE class (light efficiency class)	A
GFE (grease filtering efficiency)	68
GFE class (grease filtering efficiency class)	D
Airflow in normal mode MIN (m3/h)	150
Airflow in normal mode MAX (m3/h)	390
Acoustic power in normal mode MIN (dB)	45,5
Acoustic power in normal mode MAX (dB)	57

Integration directive EU 66/2014

<i>f</i> (time increase factor)	1,6
EEl (Energy Efficiency Index)	78,2
PBEP (maximum efficiency at pressure point) (Pa)	12,5
WBEP (power consumption at maximum efficiency) (W)	69
WL (nominal power lighting system) (W)	7
EMIDDLE (Average illuminance on the cooking surface) (lux)	252

External Dimensions

Depth (mm)	440
Maximum total height (mm)	181
Diamètre de sortie (mm)	120

Characteristics

Motor quantity	1
Motor model	TF2003
Maximum pressure (Pa)	194
Filter technology	Aluminium mesh
Control technology	Mechanical rocker switch
Power levels	2
Timer	-
Filter saturation indicator	-
Charcoal filter replacement indicator	-
Dimmer function	-
Connectivity	-
Remote control	-
Display	-

Lighting

Light model	ECOLED
-------------	--------

Installation

Minimum distance to electric plate (mm)	556
Minimum distance to gas plate (mm)	656
Inner shield	German;ES_Spanish;PT_Portuguese;FR_F

Electric connection

Nominal voltage (V)	220-240
Nominal frequency (Hz)	50
Nominal input power (W)	107
Electric shock protection	Class I

Accessories

Activated charcoal filter	02825267
Noiseless flexible duct	02800004