

CORONA X 80

Cod. **02188308**

EAN **8422248110532**

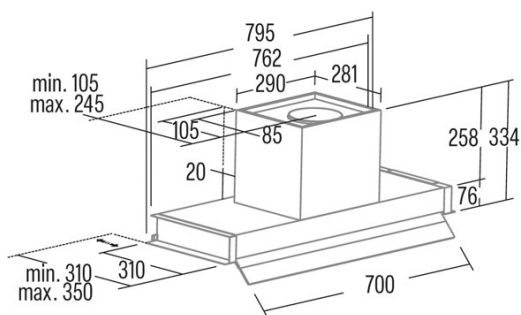

GENERAL INFORMATION

EAN/UPC	8422248110532
Subfamily	Integrated

Product sheet according to directives EU65/2014 - EN61591, EN60704-2-13, EN50564

AEC (Annual energy consumption) (kWh/year)	53,6
EEl class (energy efficiency class)	A
FDE (fluid dynamic efficiency)	30,6
FDE class (fluid dynamic efficiency class)	A
LE (light efficiency) (Lux/W)	55,7
LE class (light efficiency class)	A
GFE (grease filtering efficiency)	84,27
GFE class (grease filtering efficiency class)	C
Airflow in normal mode MIN (m3/h)	340
Airflow in normal mode MAX (m3/h)	600
Airflow in boost mode MIN (m3/h)	850
Acoustic power in normal mode MIN (dB)	50
Acoustic power in normal mode MAX (dB)	65
Acoustic power boost mode (dB)	67
Po (energy consumption in off mode) (W)	0,45
Ps (energy consumption in standby mode) (W)	0

Integration directive EU 66/2014

f (time increase factor)	0,9
QBEP (maximum efficiency at air flow point) (m3/h)	416,9
PBEP (maximum efficiency at pressure point) (Pa)	411
WBEP (power consumption at maximum efficiency) (W)	155,7
WL (nominal power lighting system) (W)	3,5
EMIDDLE (Average illuminance on the cooking surface) (lux)	195

External Dimensions

Width (mm)	795
Depth (mm)	310
Maximum total height (mm)	334
Minimum total height (mm)	334
Diamètre de sortie (mm)	150, 125

Characteristics

Motor quantity	1
Motor model	BT3
Maximum pressure (Pa)	470
Filter technology	Aluminium mesh
Control technology	Mechanical push button
Booster	✓
Power levels	4
Timer	✓
Filter saturation indicator	-
Charcoal filter replacement indicator	-
Dimmer function	-
Connectivity	No
Remote control	-
Display	-

Lighting

Light model	SSLED
Ray technology	LED

Installation

Minimum distance to electric plate (mm)	550
Minimum distance to gas plate (mm)	650
Recirculation option	-

Charcoal filter	√
Back draught shutter	-
Inner shield	-

Electric connection

Nominal voltage (V)	220-240
Nominal frequency (Hz)	50
Nominal input power (W)	283,5
Electric shock protection	Class II
Plug type	No plug

Accessories

Upper decorative duct extension	02861306
Activated charcoal filter	02859398
Noiseless flexible duct	02893002
