

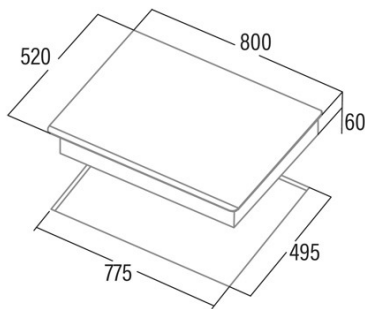

# INSB 8021 BK

Cod. **08081401**

EAN **8422248109536**

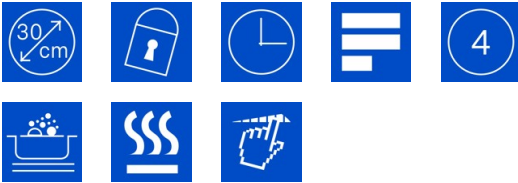

## GENERAL INFORMATION

|           |               |
|-----------|---------------|
| EAN/UPC   | 8422248109536 |
| Subfamily | Induction     |

## Product sheet

|                               |                      |
|-------------------------------|----------------------|
| Number of cooking zones       | 4                    |
| Zone 1: Technology            | Induction            |
| Zone 1: Type of zone          | Rectangular Flexible |
| Zone 1: Position              | Front Left           |
| Zone 1: Zone diameter (mm)    | 21x20                |
| Zone 1: Power (kW)            | 1,5                  |
| Zone 1: Booster (kW)          | 2                    |
| Zone 1: Consumption (Wh / kg) | 182,9                |
| Zone 1B: Zone diameter (mm)   | N/A                  |
| Zone 1C: Zone diameter (mm)   | N/A                  |
| Zone 2: Technology            | Induction            |
| Zone 2: Type of zone          | Rectangular Flexible |
| Zone 2: Position              | Rear Left            |
| Zone 2: Zone diameter (mm)    | 21x20                |
| Zone 2: Power (kW)            | 2                    |
| Zone 2: Booster (kW)          | 2,8                  |
| Zone 2: Consumption (Wh / kg) | 182,7                |
| Zone 2B: Zone diameter (mm)   | N/A                  |
| Zone 2C: Zone diameter (mm)   | N/A                  |
| Zone 3: Technology            | Induction            |
| Zone 3: Type of zone          | Simple               |
| Zone 3: Position              | Centre               |
| Zone 3: Zone diameter (mm)    | 30                   |
| Zone 3: Power (kW)            | 2,3                  |
| Zone 3: Booster (kW)          | 3                    |
| Zone 3: Consumption (Wh / kg) | 216,3                |
| Zone 3B: Zone diameter (mm)   | N/A                  |
| Zone 3C: Zone diameter (mm)   | N/A                  |
| Zone 4: Technology            | Induction            |
| Zone 4: Type of zone          | Simple               |
| Zone 4: Position              | Front Right          |
| Zone 4: Zone diameter (mm)    | 18                   |
| Zone 4: Power (kW)            | 1,2                  |
| Zone 4: Booster (kW)          | 1,5                  |
| Zone 4: Consumption (Wh / kg) | 179,5                |
| Zone 4B: Zone diameter (mm)   | N/A                  |
| Zone 4C: Zone diameter (mm)   | N/A                  |
| Zone 5: Technology            | N/A                  |
| Zone 5: Type of zone          | N/A                  |
| Zone 5: Position              | N/A                  |
| Zone 5: Zone diameter (mm)    | N/A                  |
| Zone 5B: Zone diameter (mm)   | N/A                  |
| Zone 5C: Zone diameter (mm)   | N/A                  |
| Zone 6: Technology            | N/A                  |
| Zone 6: Type of zone          | N/A                  |
| Zone 6: Position              | N/A                  |
| Zone 6: Zone diameter (mm)    | N/A                  |
| Zone 6B: Zone diameter (mm)   | N/A                  |
| Zone 6C: Zone diameter (mm)   | N/A                  |

## Dimensions

|                      |     |
|----------------------|-----|
| Width (mm)           | 800 |
| Height (mm)          | 60  |
| Depth (mm)           | 520 |
| Built-in width (mm)  | 745 |
| Built-in height (mm) | 56  |
| Built-in depth (mm)  | 495 |

Easy installation system

Quick Fix

---

### Finishing

|                  |       |
|------------------|-------|
| Material         | Glass |
| Bevel            | Front |
| Frame            | No    |
| Cooking supports | N/A   |

---

### Control

|                             |                      |
|-----------------------------|----------------------|
| Control type                | Slider Touch Control |
| Control position            | Front Centre         |
| Independent zone control    | √                    |
| Hidden control              | -                    |
| Power levels                | 9 + Booster          |
| Knob type                   | N/A                  |
| Cooking time programming    | √                    |
| Countdown alarm             | √                    |
| Power management            | -                    |
| Available power limits (kW) | 2,8/3,5              |
| Connectivity                | Pro                  |
| Autoignition                | N/A                  |

---

### Safety

|                              |           |
|------------------------------|-----------|
| Safety lock                  | √         |
| Child lock                   | Yes (Key) |
| Residual heat indicator      | √         |
| Automatic cookware detection | √         |
| Smart cookware detection     | -         |
| Automatic safety shutdown    | √         |
| Liquid spill detection       | √         |
| Safety valve                 | -         |

---

### Electrical connection

|                              |          |
|------------------------------|----------|
| Nominal voltage (V)          | 220-240  |
| Nominal frequency (Hz)       | 50/60    |
| Nominal input power (W)      | 7,2      |
| Multiphase connection option | 2 phases |
| Electric shock protection    | Class I  |
| Power cord length (m)        | 1        |
| Plug type                    | No plug  |

---

### Accessories

|                |         |
|----------------|---------|
| Barbecue grill | 3017400 |
|----------------|---------|

---