

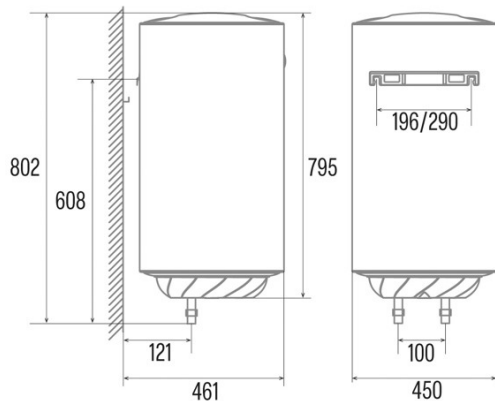

CTR-80-M

Cod. 03112003

EAN 8422248081542



GENERAL INFORMATION

EAN/UPC	8422248081542
Subfamily	Electric

Product fiche according to EU Regulation No 812/2012

Declared load profile	M
Water heating energy class	C
Water heating energy efficiency (%)	37,1
Annual electricity consumption (kWh/year)	1382
Thermostat temperature settings	75

Features

Capacity (L)	80
Number of people	2-4
Instalación	Vertical
Minimum fixed temperature	30
Maximum settings temperature	75
Type of heating element	Enamel
Heating time 15°C-65°C (min)	186,6
Static losses at 65°C (kWh/24h)	1,38
Coating thickness (mm)	5

Controls

Control type	Mechanical
Control position	Bottom
Electrical connection indicator	-
Temperature indicator	√
Heating indicator	√

Safety

Overheating protection	√
Safety temperature (°C)	82
Freezing protection	-
Water protection index	IPX4
Maximum working pressure (Mpa)	0,75
Magnesium anode dimensions (mm)	D22x296

Power connection

Nominal voltage (V)	220-240
Nominal frequency (Hz)	50/60
Nominal input power (W)	1500
Electric shock protection	Class I
Power cord length (m)	1,5
Plug type	Type F

Installation

Width (mm)	450
Height (mm)	805
Depth (mm)	450