

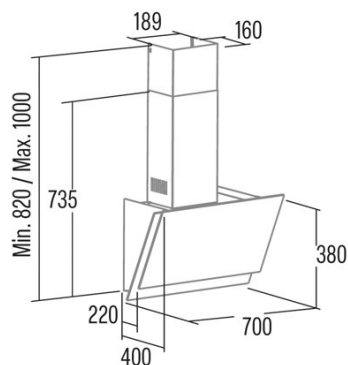

JUNO+ 7000 GBK 220-240V 50/60Hz

Cod. 02078701

EAN 8422248355636



GENERAL INFORMATION

EAN/UPC	8422248355636
Subfamily	Angle Glass

Product sheet according to directives EU65/2014 - EN61591, EN60704-2-13, EN50564

AEC (Annual energy consumption) (kWh/year)	23,1
EEl class (energy efficiency class)	A+
FDE (fluid dynamic efficiency)	33,5
FDE class (fluid dynamic efficiency class)	A
LE (light efficiency) (Lux/W)	22,6
LE class (light efficiency class)	B
GFE (grease filtering efficiency)	60,9
GFE class (grease filtering efficiency class)	C
Airflow in normal mode MIN (m3/h)	170
Airflow in normal mode MAX (m3/h)	385
Airflow in boost mode MIN (m3/h)	562
Acoustic power in normal mode MIN (dB)	44
Acoustic power in normal mode MAX (dB)	61
Acoustic power boost mode (dB)	69
Po (energy consumption in off mode) (W)	0,27
Ps (energy consumption in standby mode) (W)	0

Integration directive EU 66/2014

f (time increase factor)	0,9
EEl (Energy Efficiency Index)	38,8
QBEP (maximum efficiency at air flow point) (m3/h)	258
PBEP (maximum efficiency at pressure point) (Pa)	284
WBEP (power consumption at maximum efficiency) (W)	62,6
WL (nominal power lighting system) (W)	5
EMIDDLE (Average illuminance on the cooking surface) (lux)	22,6

External Dimensions

Width (mm)	900
Depth (mm)	400
Maximum total height (mm)	1000
Minimum total height (mm)	820
Diamètre de sortie (mm)	150

Characteristics

Motor quantity	1
Motor model	T1DC
Maximum pressure (Pa)	250
Filter technology	Aluminium mesh
Control technology	Electronic Touch Control
Booster	√
Power levels	6
Timer	√
Filter saturation indicator	√
Charcoal filter replacement indicator	√
Dimmer function	√
Connectivity	√
Remote control	-
Display	Display_grafico

Lighting

Light model	SSLED
Ray technology	LED

Installation

Minimum distance to electric plate (mm)	500
Minimum distance to gas plate (mm)	650

Recirculation option	-
Charcoal filter	-
Back draught shutter	No
Inner shield	-

Electric connection

Nominal voltage (V)	220-240
Nominal frequency (Hz)	50/60
Nominal input power (W)	110
Electric shock protection	Class I
Power cord length (m)	1,3
Plug type	No plug

Accessories

Activated charcoal filter	'02859394
Noiseless flexible duct	'02859394
