

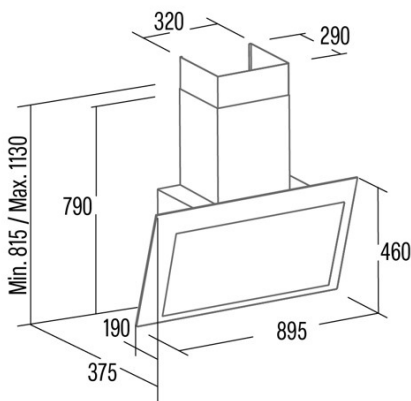

THALASSA PRO 90 GWH

Cod. **02139007**

EAN **8422248356336**



GENERAL INFORMATION

| | |
|-----------|---------------|
| EAN/UPC | 8422248356336 |
| Subfamily | Angle Glass |

Product sheet according to directives EU65/2014 - EN61591, EN60704-2-13, EN50564

| | |
|---|------|
| AEC (Annual energy consumption) (kWh/year) | 16,8 |
| EEl class (energy efficiency class) | A+++ |
| FDE (fluid dynamic efficiency) | 40,3 |
| FDE class (fluid dynamic efficiency class) | A |
| LE (light efficiency) (Lux/W) | 23,7 |
| LE class (light efficiency class) | B |
| GFE (grease filtering efficiency) | 75,5 |
| GFE class (grease filtering efficiency class) | C |
| Airflow in normal mode MIN (m3/h) | 283 |
| Airflow in normal mode MAX (m3/h) | 640 |
| Airflow in boost mode MIN (m3/h) | 842 |
| Acoustic power in normal mode MIN (dB) | 46 |
| Acoustic power in normal mode MAX (dB) | 64 |
| Acoustic power boost mode (dB) | 69 |
| Po (energy consumption in off mode) (W) | 0 |
| Ps (energy consumption in standby mode) (W) | 0,35 |

Integration directive EU 66/2014

| | |
|--|-------|
| f (time increase factor) | 0,5 |
| EEl (Energy Efficiency Index) | 27,5 |
| QBEP (maximum efficiency at air flow point) (m3/h) | 369,6 |
| PBEP (maximum efficiency at pressure point) (Pa) | 314 |
| WBEP (power consumption at maximum efficiency) (W) | 80 |
| WL (nominal power lighting system) (W) | 3 |
| EMIDDLE (Average illuminance on the cooking surface) (lux) | 71 |

External Dimensions

| | |
|---------------------------|------|
| Width (mm) | 900 |
| Depth (mm) | 375 |
| Maximum total height (mm) | 1130 |
| Minimum total height (mm) | 815 |
| Diamètre de sortie (mm) | 150 |

Characteristics

| | |
|---------------------------------------|--------------------------|
| Motor quantity | 1 |
| Motor model | BT4DC |
| Maximum pressure (Pa) | 450 |
| Filter technology | Aluminium mesh |
| Control technology | Electronic Touch Control |
| Booster | √ |
| Power levels | 6 |
| Timer | √ |
| Filter saturation indicator | √ |
| Charcoal filter replacement indicator | √ |
| Dimmer function | √ |
| Connectivity | √ |
| Remote control | - |
| Display | Display |

Lighting

| | |
|----------------|-------|
| Light model | SSLED |
| Ray technology | LED |

Installation

| | |
|---|-----|
| Minimum distance to electric plate (mm) | 450 |
| Minimum distance to gas plate (mm) | 650 |

| | |
|----------------------|----|
| Recirculation option | √ |
| Charcoal filter | √ |
| Back draught shutter | No |
| Inner shield | - |

Electric connection

| | |
|---------------------------|---------|
| Nominal voltage (V) | 220-240 |
| Nominal frequency (Hz) | 50/60 |
| Nominal input power (W) | 138 |
| Electric shock protection | Class I |
| Plug type | No plug |

Accessories

| | |
|---------------------------------|----------|
| Upper decorative duct extension | 02861300 |
| White decorative duct | 02861001 |
| Black decorative duct | 02861401 |
| Back draught shutter | 02832004 |
| Activated charcoal filter | 02859318 |
| Noiseless flexible duct | 02893002 |
| Recirculation kit | 02800013 |
