

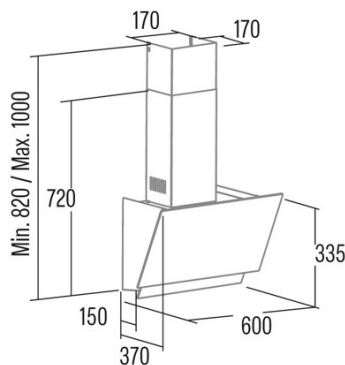

JUNO 6000 GBK 220-240V 50/60Hz

Cod. **02027700**

EAN **8422248355599**



INFORMACIÓN GENERAL

EAN/UPC	8422248355599
Subfamily	Angle Glass

Product fiche according to directives EU65/2014 - EN61591, EN60704-2-13, EN50564

AEC (Energy consumption per year) (kWh/año)	459
EEl class (Energy efficiency class)	A+
FDE (Fluid dynamic efficiency)	27,6
FDE class (Fluid dynamic efficiency class)	A
LE (Light efficiency) (lux/W)	32
LE class (Light efficiency class)	A
GFE (Grease filtering efficiency)	67,9
GFE Class (Grease filtering efficiency class)	D
Normal mode airflow MIN (m3/h)	170
Normal mode airflow MAX (m3/h)	387,5
Boost mode airflow (m3/h)	428
Normal mode acoustic power MIN (dB)	80
Normal mode acoustic power MAX (dB)	64
Boost mode acoustic power (dB)	70
Po (Off-mode power consumption) (W)	0,46
Ps (Stand-by power consumption) (W)	0

Integration directive EU 66/2014

<i>f</i> (Factor Increase in the time)	0,9
EEl (Energy efficiency Index)	402
QBEP (Maximum airflow point efficiency) (m3/h)	213
PBEP (Maximum pressure point efficiency) (Pa)	261
WBEP (Electrical power consumption at maximum efficiency) (W)	60,3
WL (Rated power lighting system) (W)	3
EMIDDLE (Average illuminance on the cooking surface) (lux)	161

External Dimensions

Width (mm)	600
Depth (mm)	370
Maximum Total Height (mm)	1000
Minimum Total Height (mm)	820
Outlet Diameter (mm)	150

Characteristics

Motor Quantity	1
Motor Model	EY450 400 A
Maximum Pressure (Pa)	230
Filter Technology	Aluminium mesh
Control Technology	Electronic Touch Control
Booster	√
Power levels	6
Timer	√
Filter Saturation Indicator	√
Charcoal Filter Change Indicator	√
Dimmer Function	√
Connectivity	√
Remote control	-
Display	Display_grafico

Lighting

Light Model	CSLED
Lightning Technology	LED

Installation

Minimum distance to an electric cooktop (mm)	400
--	-----

Minimum distance to a gas cooktop (mm)	650
Recirculation Option	√
Charcoal Filter	-
Back Draught Shutter	No
Inner shield	-

Electric Connection

Rated voltage (V)	220-240
Rated frequency (Hz)	50/60
Rated power input (W)	73
Protection against electric shock	Class I
Plug type	No plug

Accessories

Active Charcoal Filter	'02859488
Noiseless Flexible Duct	'02893002
