

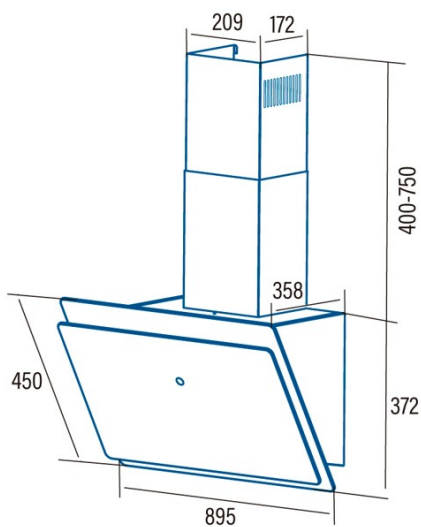

# WANDA 900 XGBK

Cod. **02059405**

EAN **8422248102308**



## INFORMACIÓN GENERAL

EAN/UPC	8422248102308
Subfamily	Angle Glass

### Product fiche according to directives EU65/2014 - EN61591, EN60704-2-13, EN50564

AEC (Energy consumption per year) (kWh/año)	14,94
EEL class (Energy efficiency class)	AP
FDE (Fluid dynamic efficiency)	31,01
FDE class (Fluid dynamic efficiency class)	A
LE (Light efficiency) (lux/W)	54,6
LE class (Light efficiency class)	A
GFE (Grease filtering efficiency)	78
GFE Class (Grease filtering efficiency class)	C
Normal mode airflow MIN (m3/h)	234,1
Normal mode airflow MAX (m3/h)	522,81
Normal mode acustic power MIN (dB)	35
Normal mode acustic power MAX (dB)	61,8
Po (Off-mode power consumption) (W)	0,45

### Integration directive EU 66/2014

f (Factor Increase in the time)	0,883
EEL (Energy efficiency Index)	38,6
QBEP (Maximum airflow point efficiency) (m3/h)	248,01
PBEP (Maximum pressure point efficiency) (Pa)	178,05
WBEP (Electrical power consumption at maximum efficiency) (W)	39,55
WL (Rated power lighting system) (W)	3
EMIDDLE (Average illuminance on the cooking surface) (lux)	163,8

### External Dimensions

Width (mm)	895
Depth (mm)	358
Maximum Total Height (mm)	1122
Minimum Total Height (mm)	772
Outlet Diameter (mm)	150

### Characteristics

Motor Quantity	1
Motor Model	BLDC
Maximum Pressure (Pa)	430
Free Outlet Airflow (m3/h)	1000
Filter Technology	Aluminium mesh
Control Tecnology	Electronic Touch Control
Booster	-
Power levels	9
Timer	√
Filter Saturation Indicator	-
Charcoal Filter Change Indicator	-
Dimmer Function	-
Connectivity	-
Remote control	-
Display	Display

### Lighting

Lightning Technology	LED
----------------------	-----

### Installation

Minimum distance to an electric cooktop (mm)	650
Minimum distance to a gas cooktop (mm)	650
Recirculation Option	√
Charcoal Filter	-

Back Draught Shutter	Included
Inner shield	-

---

### Electric Connection

Rated voltage (V)	220-240
Rated frequency (Hz)	50/60
Rated power input (W)	73
Protection against electric shock	Class I
Plug type	Type F

---

### Accessories

Upper Decorative Duct Extension	No
White Decorative Duct	No
Black Decorative Duct	No
Island Tube Enhancer	No
Back Draught Shutter	Included
MAX PRO Metal Filter	No
Active Charcoal Filter	2859492
Noiseless Flexible Duct	2893002
Recirculating kit	2894400

---