

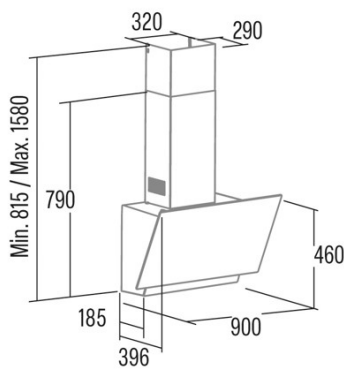

THALASSA 600 GWH

Cod. **02136006**

EAN **8422248356275**



INFORMACIÓN GENERAL

EAN/UPC	8422248356275
Subfamily	Angle Glass

Product fiche according to directives EU65/2014 - EN61591, EN60704-2-13, EN50564

AEC (Energy consumption per year) (kWh/año)	58,6
EEl class (Energy efficiency class)	A
FDE (Fluid dynamic efficiency)	29,4
FDE class (Fluid dynamic efficiency class)	A
LE (Light efficiency) (lux/W)	23,7
LE class (Light efficiency class)	B
GFE (Grease filtering efficiency)	75,5
GFE Class (Grease filtering efficiency class)	C
Normal mode airflow MIN (m3/h)	346
Normal mode airflow MAX (m3/h)	600
Boost mode airflow (m3/h)	811
Normal mode acoustic power MIN (dB)	50
Normal mode acoustic power MAX (dB)	65
Boost mode acoustic power (dB)	67
Po (Off-mode power consumption) (W)	0
Ps (Stand-by power consumption) (W)	0,43

Integration directive EU 66/2014

f (Factor Increase in the time)	0,9
EEl (Energy efficiency Index)	52,7
QBEP (Maximum airflow point efficiency) (m3/h)	457,2
PBEP (Maximum pressure point efficiency) (Pa)	397
WBEP (Electrical power consumption at maximum efficiency) (W)	171,6
WL (Rated power lighting system) (W)	3
EMIDDLE (Average illuminance on the cooking surface) (lux)	71

External Dimensions

Width (mm)	600
Depth (mm)	375
Maximum Total Height (mm)	1130
Minimum Total Height (mm)	815
Outlet Diameter (mm)	150

Characteristics

Motor Quantity	1
Motor Model	BT3
Maximum Pressure (Pa)	450
Filter Technology	Aluminium mesh
Control Technology	Electronic Touch Control
Booster	√
Power levels	6
Timer	√
Filter Saturation Indicator	√
Charcoal Filter Change Indicator	√
Dimmer Function	√
Connectivity	√
Remote control	-
Display	Display

Lighting

Light Model	SSLED
Lightning Technology	LED

Installation

Minimum distance to an electric cooktop (mm)	450
--	-----

Minimum distance to a gas cooktop (mm)	650
Recirculation Option	√
Charcoal Filter	√
Back Draught Shutter	No
Inner shield	-

Electric Connection

Rated voltage (V)	220-240
Rated frequency (Hz)	50/60
Rated power input (W)	283
Protection against electric shock	Class II
Plug type	No plug

Accessories

Upper Decorative Duct Extension	02861300
White Decorative Duct	02861001
Black Decorative Duct	02861401
Back Draught Shutter	02832004
Active Charcoal Filter	02859398
Noiseless Flexible Duct	02893002
Recirculating kit	02800013
