

# ARMONIA 90 X

Cod. **02189309**

EAN **8422248110587**

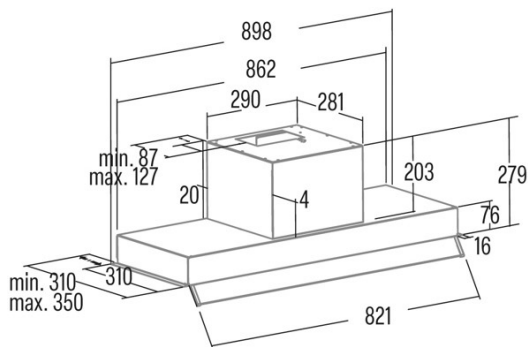

## INFORMACIÓN GENERAL

EAN/UPC	8422248110587
Subfamily	Integrated

## Product fiche according to directives EU65/2014 - EN61591, EN60704-2-13, EN50564

AEC (Energy consumption per year) (kWh/año)	100,9
EEl class (Energy efficiency class)	C
FDE (Fluid dynamic efficiency)	16,3
FDE class (Fluid dynamic efficiency class)	D
LE (Light efficiency) (lux/W)	21,4
LE class (Light efficiency class)	B
GFE (Grease filtering efficiency)	88,5
GFE Class (Grease filtering efficiency class)	B
Normal mode airflow MIN (m3/h)	385
Normal mode airflow MAX (m3/h)	645
Normal mode acoustic power MIN (dB)	56
Normal mode acoustic power MAX (dB)	70
Po (Off-mode power consumption) (W)	0
Ps (Stand-by power consumption) (W)	0

## Integration directive EU 66/2014

f (Factor Increase in the time)	1,4
EEl (Energy efficiency Index)	82,4
QBEP (Maximum airflow point efficiency) (m3/h)	375,3
PBEP (Maximum pressure point efficiency) (Pa)	295
WBEP (Electrical power consumption at maximum efficiency) (W)	188,8
WL (Rated power lighting system) (W)	6
EMIDDLE (Average illuminance on the cooking surface) (lux)	269

## External Dimensions

Width (mm)	898
Depth (mm)	310
Maximum Total Height (mm)	280
Minimum Total Height (mm)	280
Outlet Diameter (mm)	150, 125

## Characteristics

Motor Quantity	1
Motor Model	TA
Maximum Pressure (Pa)	430
Filter Technology	Aluminium mesh
Control Technology	Mechanical push button
Booster	-
Power levels	3
Timer	-
Filter Saturation Indicator	-
Charcoal Filter Change Indicator	-
Dimmer Function	-
Connectivity	No
Remote control	-
Display	-

## Lighting

Light Model	CSLED
Lightning Technology	LED

## Installation

Minimum distance to an electric cooktop (mm)	550
Minimum distance to a gas cooktop (mm)	650
Recirculation Option	-

Charcoal Filter	√
Back Draught Shutter	No
Inner shield	-

---

**Electric Connection**

Rated voltage (V)	220-240
Rated frequency (Hz)	50
Rated power input (W)	276
Protection against electric shock	Class II
Plug type	No plug

---

**Accessories**

Upper Decorative Duct Extension	02861306
Active Charcoal Filter	02859391
Noiseless Flexible Duct	02893002

---