

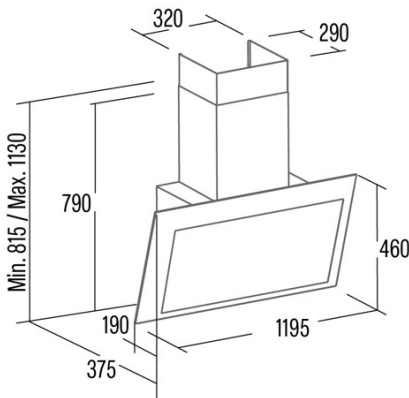

# THALASSA PRO 90 GWH

Cod. **02139007**

EAN **8422248356336**

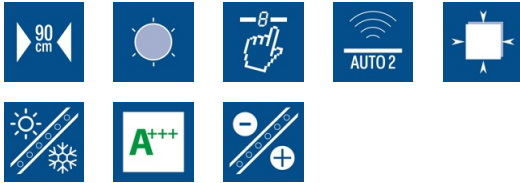

## INFORMACIÓN GENERAL

EAN/UPC	8422248356336
Subfamily	Angle Glass

### Product fiche according to directives EU65/2014 - EN61591, EN60704-2-13, EN50564

AEC (Energy consumption per year) (kWh/año)	16,8
EEl class (Energy efficiency class)	A+++
FDE (Fluid dynamic efficiency)	40,3
FDE class (Fluid dynamic efficiency class)	A
LE (Light efficiency) (lux/W)	23,7
LE class (Light efficiency class)	B
GFE (Grease filtering efficiency)	75,5
GFE Class (Grease filtering efficiency class)	C
Normal mode airflow MIN (m3/h)	283
Normal mode airflow MAX (m3/h)	640
Boost mode airflow (m3/h)	842
Normal mode acoustic power MIN (dB)	46
Normal mode acoustic power MAX (dB)	64
Boost mode acoustic power (dB)	69
Po (Off-mode power consumption) (W)	0
Ps (Stand-by power consumption) (W)	0,35

### Integration directive EU 66/2014

f (Factor Increase in the time)	0,5
EEl (Energy efficiency Index)	27,5
QBEP (Maximum airflow point efficiency) (m3/h)	369,6
PBEP (Maximum pressure point efficiency) (Pa)	314
WBEP (Electrical power consumption at maximum efficiency) (W)	80
WL (Rated power lighting system) (W)	3
EMIDDLE (Average illuminance on the cooking surface) (lux)	71

### External Dimensions

Width (mm)	900
Depth (mm)	375
Maximum Total Height (mm)	1130
Minimum Total Height (mm)	815
Outlet Diameter (mm)	150

### Characteristics

Motor Quantity	1
Motor Model	BT4DC
Maximum Pressure (Pa)	450
Filter Technology	Aluminium mesh
Control Technology	Electronic Touch Control
Booster	√
Power levels	6
Timer	√
Filter Saturation Indicator	√
Charcoal Filter Change Indicator	√
Dimmer Function	√
Connectivity	√
Remote control	-
Display	Display

### Lighting

Light Model	SSLED
Lightning Technology	LED

### Installation

Minimum distance to an electric cooktop (mm)	450
--	-----

Minimum distance to a gas cooktop (mm)	650
Recirculation Option	√
Charcoal Filter	√
Back Draught Shutter	No
Inner shield	-

---

### Electric Connection

Rated voltage (V)	220-240
Rated frequency (Hz)	50/60
Rated power input (W)	138
Protection against electric shock	Class I
Plug type	No plug

---

### Accessories

Upper Decorative Duct Extension	02861300
White Decorative Duct	02861001
Black Decorative Duct	02861401
Back Draught Shutter	02832004
Active Charcoal Filter	02859318
Noiseless Flexible Duct	02893002
Recirculating kit	02800013

---