

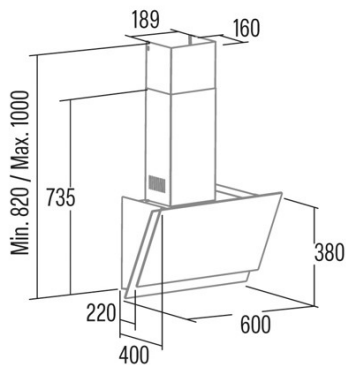

# JUNO+ 6000 GBK 220-240V 50/60Hz

Cod. 02027701

EAN 8422248355629



## INFORMACIÓN GENERAL

EAN/UPC	8422248355629
Subfamily	Angle Glass

## Product fiche according to directives EU65/2014 - EN61591, EN60704-2-13, EN50564

AEC (Energy consumption per year) (kWh/año)	23,1
EEl class (Energy efficiency class)	A+
FDE (Fluid dynamic efficiency)	33,5
FDE class (Fluid dynamic efficiency class)	A
LE (Light efficiency) (lux/W)	22,6
LE class (Light efficiency class)	B
GFE (Grease filtering efficiency)	60,9
GFE Class (Grease filtering efficiency class)	C
Normal mode airflow MIN (m3/h)	170
Normal mode airflow MAX (m3/h)	385
Boost mode airflow (m3/h)	562
Normal mode acoustic power MIN (dB)	44
Normal mode acoustic power MAX (dB)	61
Boost mode acoustic power (dB)	69
Po (Off-mode power consumption) (W)	0,27
Ps (Stand-by power consumption) (W)	0

## Integration directive EU 66/2014

f (Factor Increase in the time)	0,9
EEl (Energy efficiency Index)	38,8
QBEP (Maximum airflow point efficiency) (m3/h)	258
PBEP (Maximum pressure point efficiency) (Pa)	284
WBEP (Electrical power consumption at maximum efficiency) (W)	62,6
WL (Rated power lighting system) (W)	5
EMIDDLE (Average illuminance on the cooking surface) (lux)	22,6

## External Dimensions

Width (mm)	900
Depth (mm)	400
Maximum Total Height (mm)	1000
Minimum Total Height (mm)	820
Outlet Diameter (mm)	150

## Characteristics

Motor Quantity	1
Motor Model	T1DC
Maximum Pressure (Pa)	250
Filter Technology	Aluminium mesh
Control Technology	Electronic Touch Control
Booster	√
Power levels	6
Timer	√
Filter Saturation Indicator	√
Charcoal Filter Change Indicator	√
Dimmer Function	√
Connectivity	√
Remote control	-
Display	Display_grafico

## Lighting

Light Model	SSLED
Lightning Technology	LED

## Installation

Minimum distance to an electric cooktop (mm)	500
--	-----

Minimum distance to a gas cooktop (mm)	650
Recirculation Option	-
Charcoal Filter	-
Back Draught Shutter	No
Inner shield	-

---

#### **Electric Connection**

Rated voltage (V)	220-240
Rated frequency (Hz)	50/60
Rated power input (W)	110
Protection against electric shock	Class I
Power cord length (m)	1,3
Plug type	No plug

---

#### **Accessories**

Active Charcoal Filter	'02859394
Noiseless Flexible Duct	'02859394

---