

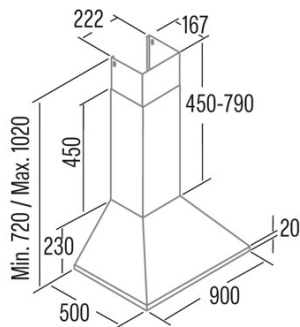

# BETA 900 X

Cod. 02051303

EAN 8422248061827



## INFORMACIÓN GENERAL

EAN/UPC	8422248061827
Subfamily	Chimney

### Product fiche according to directives EU65/2014 - EN61591, EN60704-2-13, EN50564

AEC (Energy consumption per year) (kWh/año)	56,3
EEL class (Energy efficiency class)	A
FDE (Fluid dynamic efficiency)	30,6
FDE class (Fluid dynamic efficiency class)	A
LE (Light efficiency) (lux/W)	36
LE class (Light efficiency class)	A
GFE (Grease filtering efficiency)	91,2
GFE Class (Grease filtering efficiency class)	B
Normal mode airflow MIN (m3/h)	340
Normal mode airflow MAX (m3/h)	600
Boost mode airflow (m3/h)	850
Normal mode acoustic power MIN (dB)	50
Normal mode acoustic power MAX (dB)	65
Boost mode acoustic power (dB)	67
Po (Off-mode power consumption) (W)	0,26
Ps (Stand-by power consumption) (W)	0

### Integration directive EU 66/2014

f (Factor Increase in the time)	0,9
EEL (Energy efficiency Index)	53,7
QBEP (Maximum airflow point efficiency) (m3/h)	416,9
PBEP (Maximum pressure point efficiency) (Pa)	411
WBEP (Electrical power consumption at maximum efficiency) (W)	155,7
WL (Rated power lighting system) (W)	7
EMIDDLE (Average illuminance on the cooking surface) (lux)	252

### External Dimensions

Width (mm)	900
Depth (mm)	500
Maximum Total Height (mm)	1020
Minimum Total Height (mm)	720
Outlet Diameter (mm)	150, 125

### Characteristics

Motor Quantity	1
Motor Model	BT3
Maximum Pressure (Pa)	450
Filter Technology	Aluminium mesh
Control Technology	PANEL ELECTRONICO
Booster	√
Power levels	3
Timer	√
Filter Saturation Indicator	-
Charcoal Filter Change Indicator	-
Dimmer Function	-
Connectivity	-
Remote control	-
Display	-

### Lighting

Light Model	EcoLed
Lightning Technology	LED

### Installation

Minimum distance to an electric cooktop (mm)	650
--	-----

Minimum distance to a gas cooktop (mm)	650
Recirculation Option	√
Charcoal Filter	-
Back Draught Shutter	-
Inner shield	-

---

### Electric Connection

Rated voltage (V)	220-240
Rated frequency (Hz)	50
Rated power input (W)	287
Protection against electric shock	Class II
Power cord length (m)	1,5
Plug type	Type C

---

### Accessories

Upper Decorative Duct Extension	2862301
White Decorative Duct	No
Black Decorative Duct	No
Island Tube Enhancer	No
Back Draught Shutter	2832004
MAX PRO Metal Filter	2800917
Active Charcoal Filter	2859398
Noiseless Flexible Duct	2893002
Recirculating kit	2894000

---