

CORONA X 80

Cod. **02188308**

EAN **8422248110532**

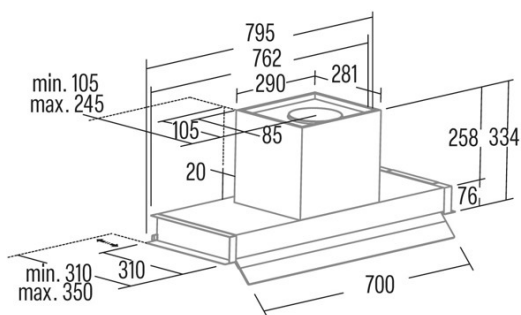

INFORMACIÓN GENERAL

EAN/UPC	8422248110532
Subfamily	Integrated

Product fiche according to directives EU65/2014 - EN61591, EN60704-2-13, EN50564

AEC (Energy consumption per year) (kWh/año)	53,6
EEL class (Energy efficiency class)	A
FDE (Fluid dynamic efficiency)	30,6
FDE class (Fluid dynamic efficiency class)	A
LE (Light efficiency) (lux/W)	55,7
LE class (Light efficiency class)	A
GFE (Grease filtering efficiency)	84,27
GFE Class (Grease filtering efficiency class)	C
Normal mode airflow MIN (m3/h)	340
Normal mode airflow MAX (m3/h)	600
Boost mode airflow (m3/h)	850
Normal mode acoustic power MIN (dB)	50
Normal mode acoustic power MAX (dB)	65
Boost mode acoustic power (dB)	67
Po (Off-mode power consumption) (W)	0,45
Ps (Stand-by power consumption) (W)	0

Integration directive EU 66/2014

f (Factor Increase in the time)	0,9
QBEP (Maximum airflow point efficiency) (m3/h)	416,9
PBEP (Maximum pressure point efficiency) (Pa)	411
WBEP (Electrical power consumption at maximum efficiency) (W)	155,7
WL (Rated power lighting system) (W)	3,5
EMIDDLE (Average illuminance on the cooking surface) (lux)	195

External Dimensions

Width (mm)	795
Depth (mm)	310
Maximum Total Height (mm)	334
Minimum Total Height (mm)	334
Outlet Diameter (mm)	150, 125

Characteristics

Motor Quantity	1
Motor Model	BT3
Maximum Pressure (Pa)	470
Filter Technology	Aluminium mesh
Control Technology	Mechanical push button
Booster	√
Power levels	4
Timer	√
Filter Saturation Indicator	-
Charcoal Filter Change Indicator	-
Dimmer Function	-
Connectivity	No
Remote control	-
Display	-

Lighting

Light Model	SSLED
Lighting Technology	LED

Installation

Minimum distance to an electric cooktop (mm)	550
Minimum distance to a gas cooktop (mm)	650

Recirculation Option	-
Charcoal Filter	√
Back Draught Shutter	-
Inner shield	-

Electric Connection

Rated voltage (V)	220-240
Rated frequency (Hz)	50
Rated power input (W)	283,5
Protection against electric shock	Class II
Plug type	No plug

Accessories

Upper Decorative Duct Extension	02861306
Active Charcoal Filter	02859398
Noiseless Flexible Duct	02893002
